

ALH 20 - FICHE TECHNIQUE

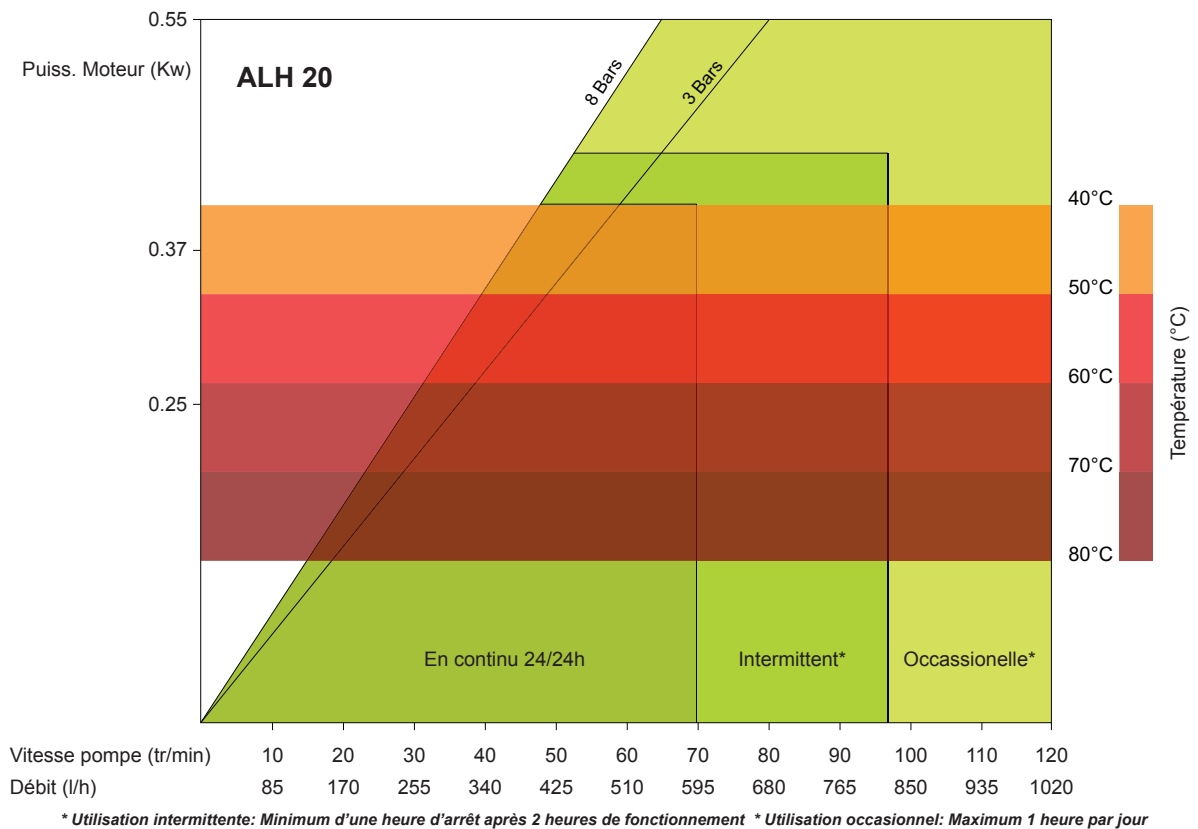

Dimensions

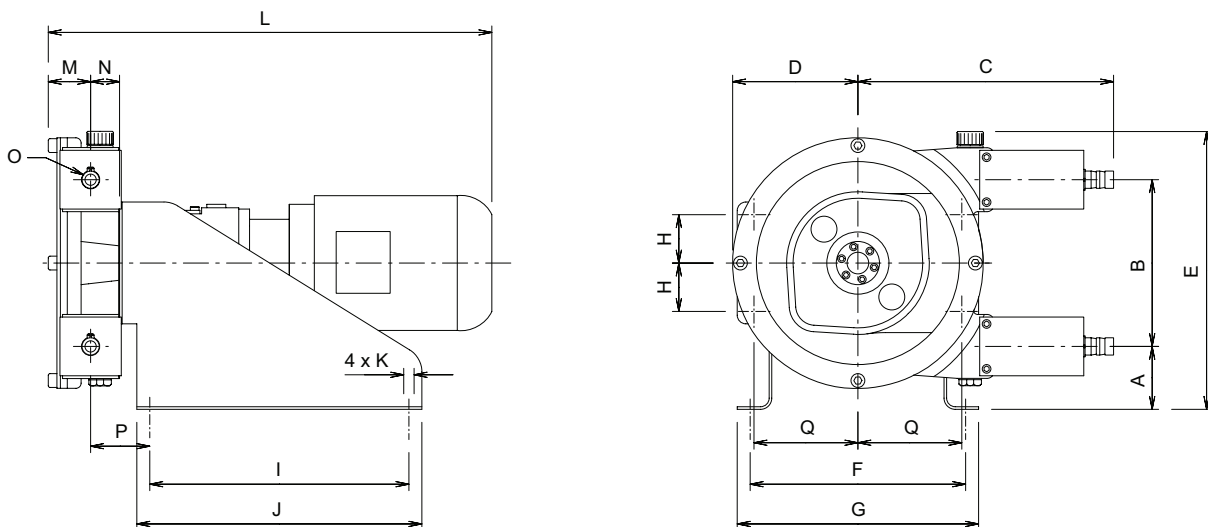

* Inserts cannelés

TYPE	A	B	C	D	E	F	G	H	I	J	K	L	M	N	O	P	Q
ALH 20	73	193	296	145	322	250	280	51,5	300	330	4xø13	-	49	35,5	ø25 *	70,5	124,75

DOCUMENT NON CONTRACTUEL